

DANIEL[®]
SENIOR ORIFICE FITTING
SPARE PARTS KIT

PACKING LEGEND

DMC-20079654

DAN-20080020

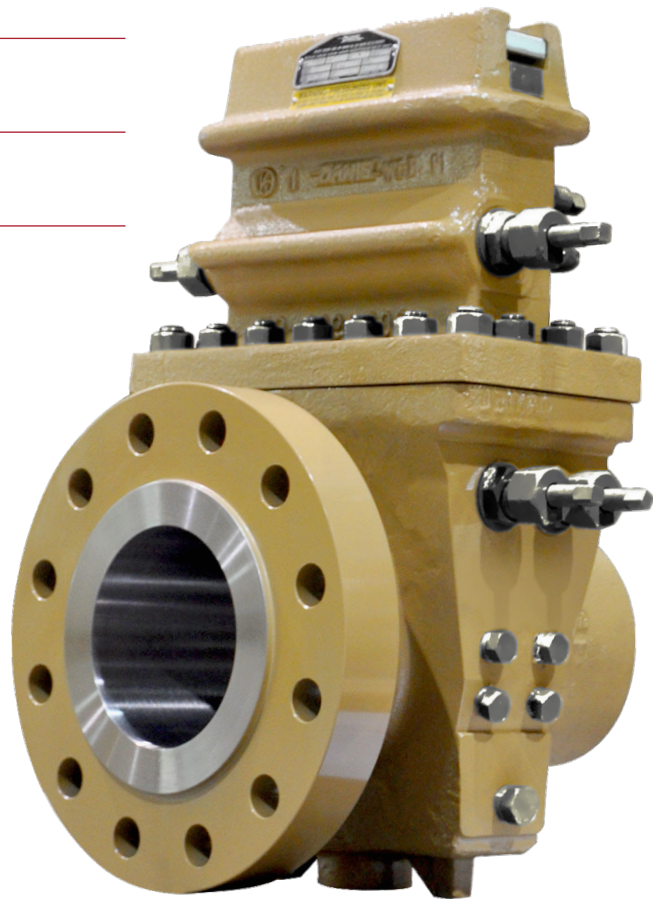

DANIEL[®]

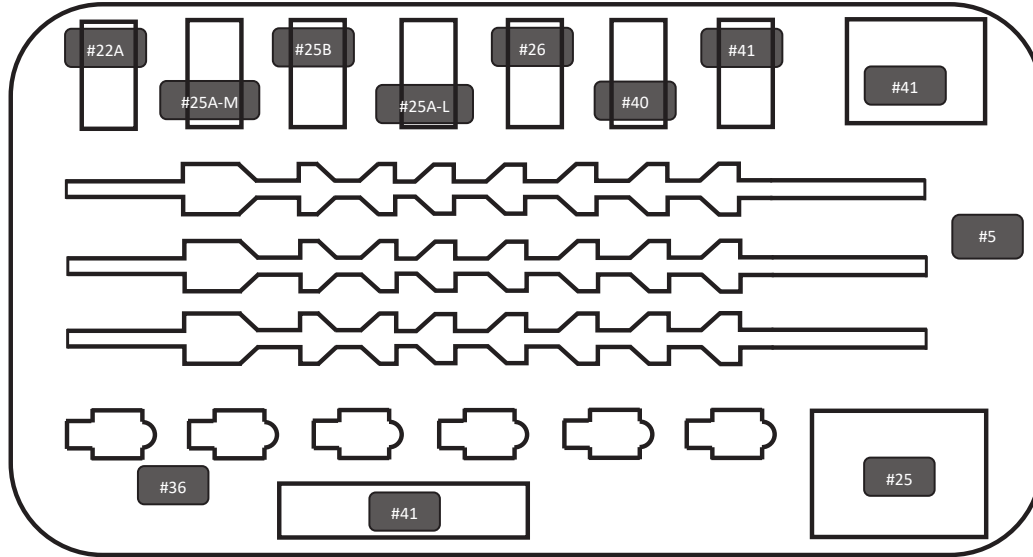

Shaft and Stuffing Box Kit	
Item Number	Part Description
#5	DOUBLE ENDED GEAR SHAFT
#22A	STUFFING BOX GASKET
#25	PACKING NUT (1-1/2" HEX)
#25A-M	TEFLON PACKING RING (5/8" X 7/8" X 3/8" LG)
#25B	TEFLON CENTERING RING (.630" ID X .890" OD X .187" LG)
#25A-L	TEFLON PACKING RING (5/8" X 7/8" X 1/2" LG)
#26	STUFFING BOX GLAND
#36	STUFFING BOX BODY
#40	STUFFING BOX SLEEVE 15/16" LG
#41*	STUFFING BOX SLEEVE 13/16" LG

*May include extras to accommodate older fittings

Applicable to the following part numbers:

- DAN-20072499
- DAN-20072558
- DAN-20072559
- DAN-20072560
- DAN-20072563
- DAN-20072564
- DAN-20072565
- DAN-20072566
- DAN-20072567

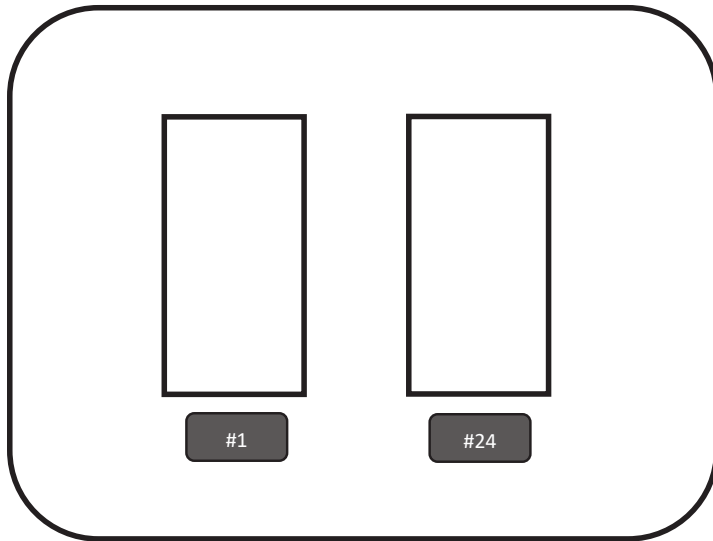

Equalizer Valve Kit	
Item Number	Part Description
#1	EQUALIZER VALVE ASSEMBLY
#24	BALL CHECK VALVE ASSEMBLY

Applicable to the following part numbers:

DAN-20072437

DAN-20072456

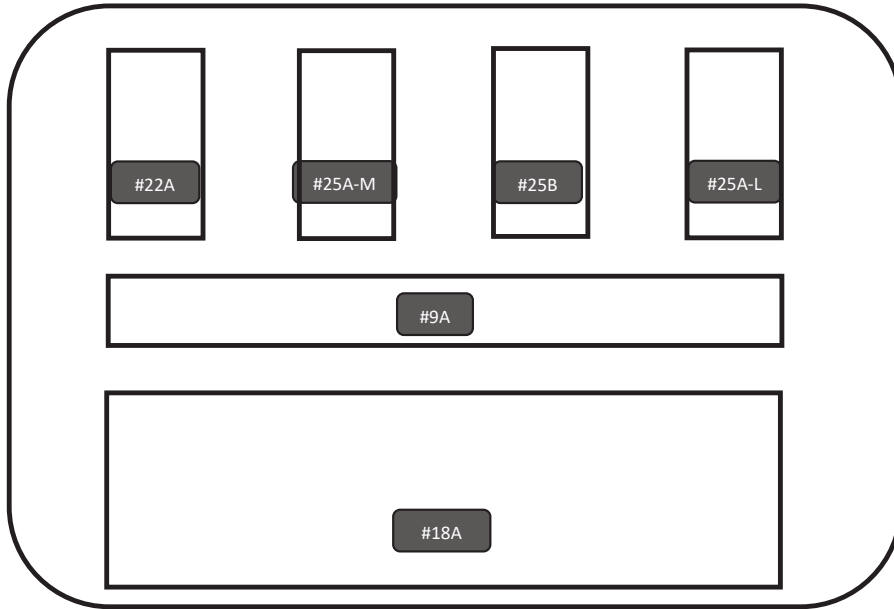

Gasket and Packing Kit (2"-6")	
Item Number	Part Description
#9A	SEALING BAR GASKET
#18A	SLIDE VALVE SEAT TOP GASKET
#22A	STUFFING BOX GASKET
#25A-M	TEFLON PACKING RING (5/8" X 7/8" X 3/8" LG)
#25B	TEFLON CENTERING RING (.630" ID X .890 OD X .187" LG)
#25A-L	TEFLON PACKING RING (5/8" X 7/8" X 1/2" LG)

Applicable to the following part numbers:

- DAN-20072472
- DAN-20072473
- DAN-20072474
- DAN-20072475

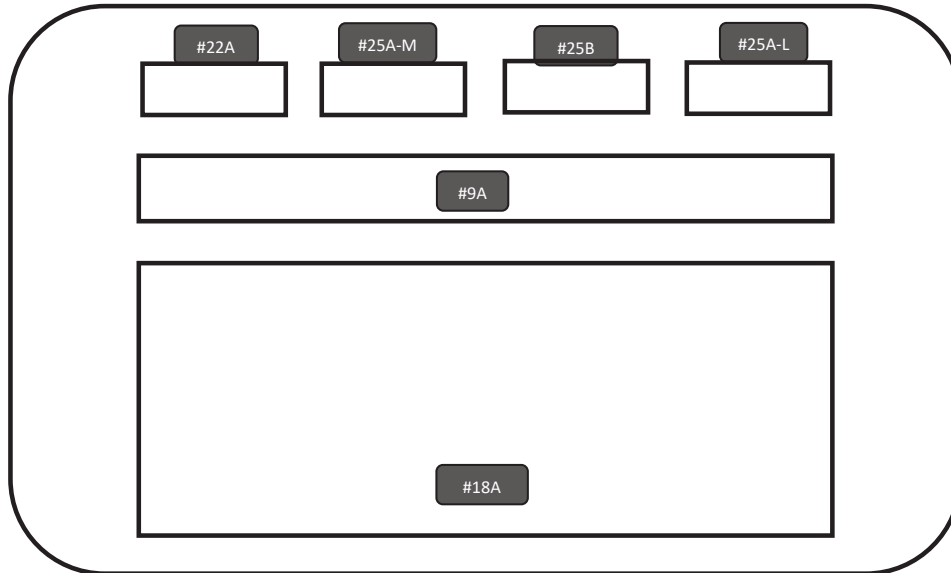

Gasket and Packing Kit (8"- 12")	
Item Number	Part Description
#9A	SEALING BAR GASKET
#18A	SLIDE VALVE SEAT TOP GASKET
#22A	STUFFING BOX GASKET
#25A-M	TEFLON PACKING RING (5/8" X 7/8" X 3/8" LG)
#25B	TEFLON CENTERING RING (.630" ID X .890 OD X .187" LG)
#25A-L	TEFLON PACKING RING (5/8" X 7/8" X 1/2" LG)

Applicable to the following part numbers:
 DAN-20072476
 DAN-20072477
 DAN-20072482

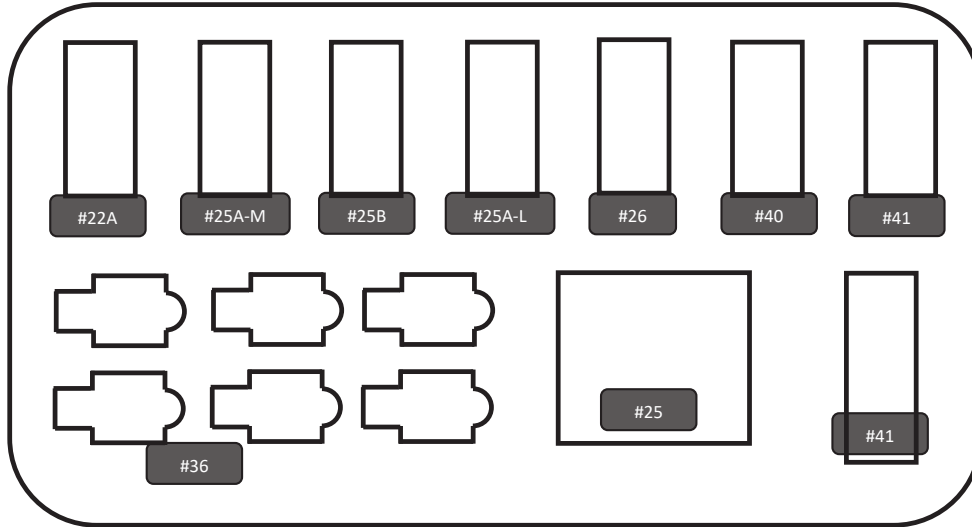

Stuffing Box Kit	
Item Number	Part Description
#22A	STUFFING BOX GASKET
#25	PACKING NUT (1-1/2" HEX)
#25A-M	TEFLON PACKING RING (5/8" X 7/8" X 3/8" LG)
#25B	TEFLON CENTERING RING (.630" ID X .890" OD X .187" LG)
#25A-L	TEFLON PACKING RING (5/8" X 7/8" X 1/2" LG)
#26	STUFFING BOX GLAND
#36	STUFFING BOX BODY
#40	STUFFING BOX SLEEVE 15/16" LG
#41	STUFFING BOX SLEEVE 13/16" LG

*May include extras to accommodate older fittings

Applicable to the following part numbers:

- DAN-20072571
- DAN-20072574
- DAN-20072675
- DAN-20072677
- DAN-20072580
- DAN-20072581
- DAN-20072582
- DAN-20072583
- DAN-20072584

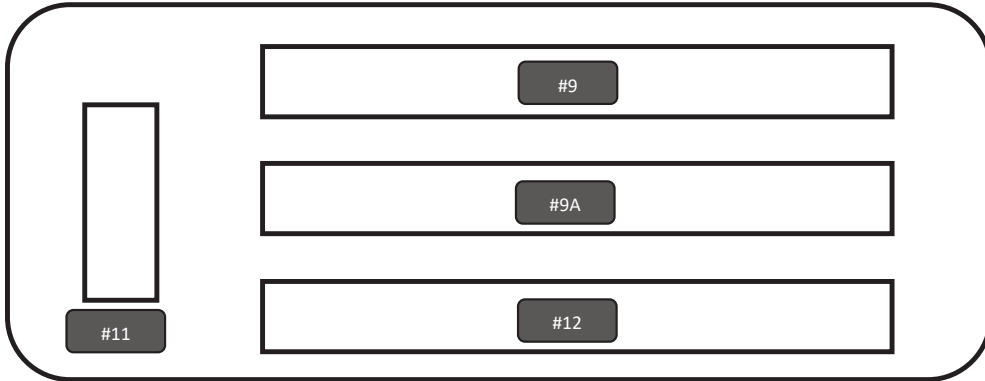

Sealing Bar and Clamping Bar Kit (2" - 6")	
Item Number	Part Description
#9	SEALING BAR
#9A	SEALING BAR GASKET
#11	CLAMPING BAR SCREW
#12	CLAMPING BAR

Applicable to the following part numbers:

DAN-20072489
 DAN-20072490
 DAN-20072491
 DAN-20072492

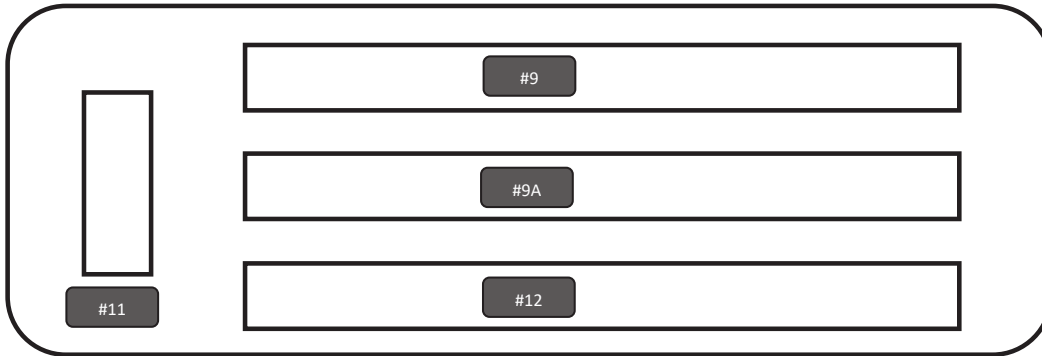

Sealing Bar and Clamping Bar Kit (8" - 12")	
Item Number	Part Description
#9	SEALING BAR
#9A	SEALING BAR GASKET
#11	CLAMPING BAR SCREW
#12	CLAMPING BAR

Applicable to the following part numbers:

- DAN-20072493
- DAN-20072494
- DAN-20072495

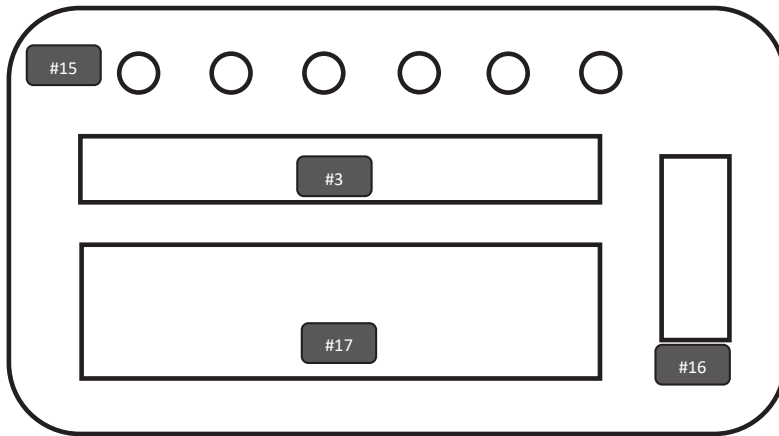

Valve Carrier and Strip Kit (2" - 6")	
Item Number	Part Description
#3	SLIDE VALVE STRIP
#15	SLIDE VALVE SPRING
#16	SLIDE VALVE CARRIER GUIDES
#17	SLIDE VALVE CARRIER

Applicable to the following part numbers:

- DAN-20072572
- DAN-20072603
- DAN-20072604
- DAN-20072606

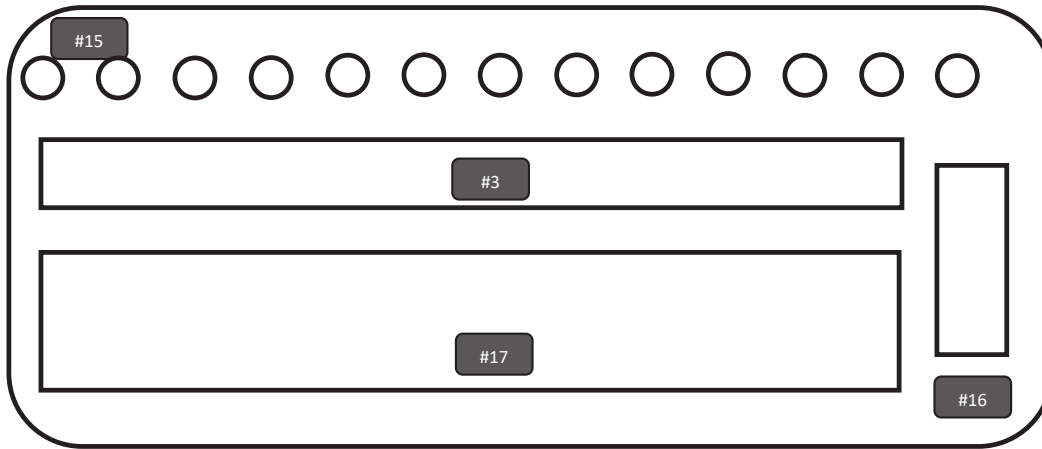

Valve Carrier and Strip Kit (8" - 12")	
Item Number	Part Description
#3	SLIDE VALVE STRIP
#15	SLIDE VALVE SPRING
#16	SLIDE VALVE CARRIER GUIDES
#17	SLIDE VALVE CARRIER

Applicable to the following part numbers:

- DAN-20072607
- DAN-20072608
- DAN-20072612
- DAN-20072613
- DAN-20072614

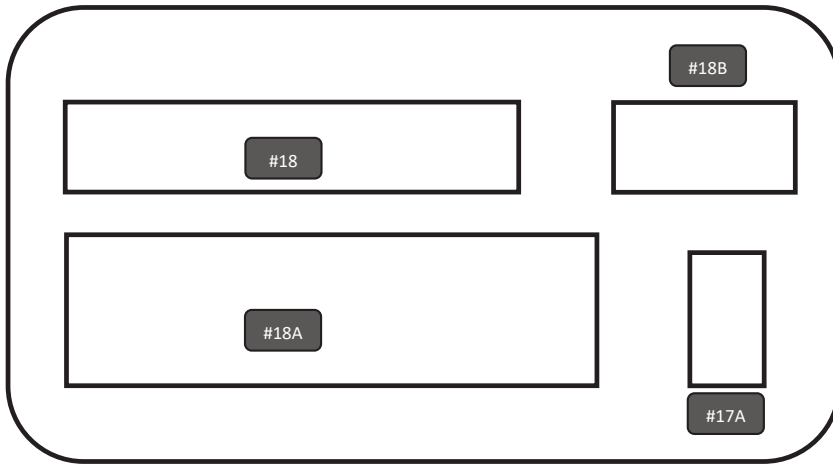

Valve Seat Kit (2"- 6")	
Item Number	Part Description
#17A	SLIDE VALVE STOP PIN
#18	SLIDE VALVE SEAT
#18A	SLIDE VALVE SEAT TOP GASKET
#18B	SLIDE VALVE SEAT SCREW

Applicable to the following part numbers:

- DAN-20072573
- DAN-20072625
- DAN-20072627
- DAN-20072630

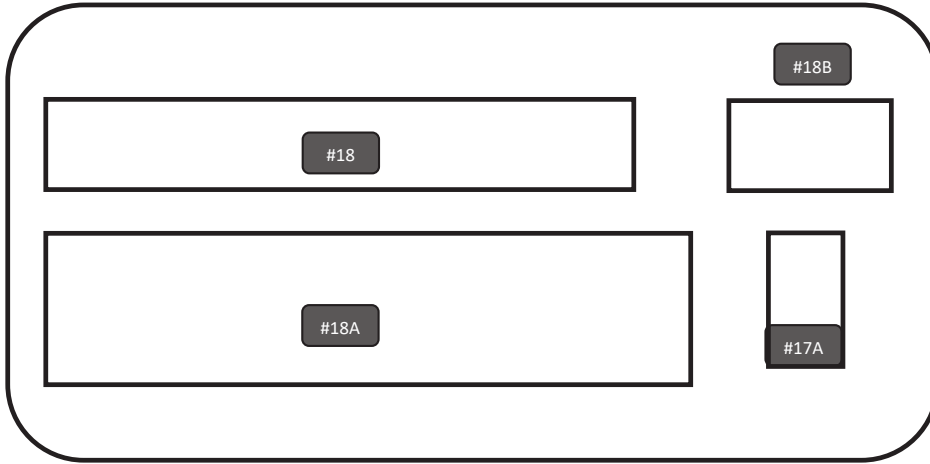

Valve Seat Kit (8" - 12")	
Item Number	Part Description
#17A	SLIDE VALVE STOP PIN
#18	SLIDE VALVE SEAT
#18A	SLIDE VALVE SEAT TOP GASKET
#18B	SLIDE VALVE SEAT SCREW

Applicable to the following part numbers:

- DAN-20072631
- DAN-20072632
- DAN-20072634
- DAN-20072636
- DAN-20072637

With over 90 years of experience, Daniel is the only manufacturer that has the knowledge and experience to engineer and offer superior products that are trusted to provide the most reliable and accurate measurements in the global oil and gas industry.

Contact Us

Email: Sales@Daniel.com
Phone: +1 (346)-509-3700



www.Daniel.com